

# WASTEWATER TREATMENT CONTAINING DATA WITH PERSISTENT ORGANIC POLLUTANTS BY ADVANCED OXIDATION PROCESSES



*CRISTINA MARIA ALDEA<sup>1</sup>*

**ABSTRACT.** – Wastewaters treatment containing data with persistent organic pollutants by advanced oxidation processes. The purpose of the paper is testing the activity of a catalyst type mixed oxide CuO-Al<sub>2</sub>O<sub>3</sub> in oxidation of acetic acid, oxalic acid and succinic acid in aqueous solutions, and analyze the influence of operational parameters: ozone dose, pH and concentration of catalyst on the process.

The method of analysis used is a high performance liquid chromatography (HPLC) and can be implemented using a chromatograph with the following features: Inertsil column, Diode Array UV detector, mobile phase: sodium phosphate with concentration 0.1 M and phosphoric acid on pH=2,5.

The results obtained by this method are: the observation of changes that occurring in the degradation under the action of ozone on the intractability pollutants considered in the analysis of sewage samples. Oxalic acid, acetic acid and succinic acid are resistant to the actions of ozone itself.

These conversion do not exceed 20% for a reaction time of 240 minutes, at ozone dose of 3,5 mg.L<sup>-1</sup>, the lowest reactivity presenting acetic acid with a maximum conversion of 8%.

Efficiency of oxidation process can be increased using catalytic systems that favour the generation hydroxyl species strong oxidizing and non-selective.

Using the couple O<sub>3</sub>/CuO -Al<sub>2</sub>O<sub>3</sub> has the effect more pronounced degradation of acids. Oxalic acid is completely degraded at high speed in a short period of time exceeding 90 minutes. Succinic acid by partial oxidation leads to oxalic.

**Keywords:** oxalic acid, succinic acid, high performance liquid chromatography (HPLC), ozone, catalyst, couple O<sub>3</sub>/CuO-Al<sub>2</sub>O<sub>3</sub>, chromatograph.

## 1. INTRODUCTION

The problem of water quality has become a priority issue for all countries of the world regardless of social economic development, so the impact on the environment and especially because of negative influence on the balance of aquatic ecosystems. Their origins are extremely varied, from industrial and domestic wastes, industrial activities generating pollution in all three states of aggregation, to agricultural practices using readily biodegradable compounds. [1-4]

Toxic substances and/or harmful, can accumulate in quantities exceeding maximum permissible limits in surface waters and groundwaters. In the category of these pollutants can be framed: sludge from processing sugar beet, flax and hemp,

---

<sup>1</sup> Agenția Națională Pentru Protecția Mediului București. E-mail: [cristinamariaaldea@yahoo.com](mailto:cristinamariaaldea@yahoo.com)



pulp, etc., which can contain more than maximum allowable limits of heavy metals, organochlorine substances such; HCH and DDT class, triazines, nitrogen and phosphorus compounds (nitrates and phosphates).[5]

The conventional methods used in wastewater treatment have low efficiency due to high costs. For this reason have developed the new methods for remediation of waste waters from the series so called "Advanced Oxidation Technologies" which ensure a high degree of degradation of pollutants going up to their mineralization by total conversion to CO<sub>2</sub> and H<sub>2</sub>O with a low power consumption.

## 2. TYPES/CLASSES OF ORGANICS POLLUTANTS IN WATERS

As we all know there are a variety of organic pollutants belonging to different classes of organic substances. [6]. Their toxic action is very different, can be manifested at concentrations order µg/l (for dioxins and furans) [7] or higher concentrations of the order of mg/l (in the case of detergents). The following are some representative classes of pollutants:

### 2.1. Haloform Compounds

In the waste waters treatment chlorine is used as an oxidising agent that can react with organic matters giving rise to haloform compounds. This reaction can take place either directly, through the chlorine present in water in the form of HOCl, or through another halogen (bromine or iodine), which reacts with organic matter to form halogenated organic compounds. Representatives of these classes are halogenated derivatives of methane ( trihalomethanes) which are formed by the following mechanism of reaction :

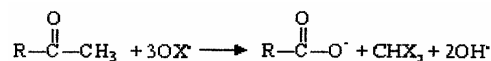

Organic matters that may give rise to this reaction are mainly methyl ketones, or more generally, all organic compounds, which can be formed by methyl ketones oxidation. All of these chloroform compounds are likely to be carcinogenic and to which pathway is important for waters treatment to ensure waters content decreased as haloform compounds.

### 2.2. Chlorinated Solvents

These pollutants occur in waters of great depth is due to industrial spills and leachate from waste dumps. In this class are: carbon tetrachloride, 1,2-dichloroethane, 1,1-dichloroethane, 1,1,1-trichloroethane. These compounds are carcinogenic and mutagenic and should be removed from water.

### 2.3. Phenols and Derivates

Phenols and their derivatives are an indicator of industrial pollution. Representatives of this class are chlorinated derivatives which have harmful effect



and occur in the presence of chlorine even at very low levels between 0.1 și 0.001  $\mu\text{g/l}$ .

#### **2.4. Hydrocarbons**

Hydrocarbons can occur in surface waters and groundwaters due to spills in the petroleum products. Their biodegradation is slow. In case of accidental pollution, their presence in surface water is of limited duration, but may be long-term groundwater (sometimes even years due to the retention in the soil).

#### **2.5. Persistent Organics Pollutants (POPs)**

Are compounds that persist in the environment for long period of time, accumulate in living organisms; are very toxic for terrestrial and aquatic organisms; arise in thermal processes such as: incineration of municipal, industrial and clinic wastes, industrial processes, recycling methals processes, e.t.c [8]. The mains categories of POPs are:

- pesticides: Aldrin, Dieldrin, Chlordane, DDT, Mirex, Toxaphene, Endrin, Heptachlor;
- Industrial chemicals substances: hexachlorobenzene, byphenyls polychlorinated;
- By products: dioxins, furans and PAH (Polycyclic Aromatics Hydrocarbons).

### **3. OXIDATION PROCESSES FOR REMOVAL OF POLLUTANTS**

For waters treatment are used especially oxidative methods. These present application on industrial scale and ensure complete removal of pollutants but is very expensive because involve high costs and high consumption of reagents [9]. Choosing of oxidising agent is very important. There are two types of oxidation processes: classical (conventional) and advanced oxidation.

#### **3.1. Classical oxidation processes**

Involve the introduction of oxidizing agent in vaters that containing the pollutant to oxidize by transformation into a less harmful compound .[10]. Applies to inorganics substances ( $\text{Mn}^{2+}$ ,  $\text{S}^{2-}$ ,  $\text{CN}^-$ ,  $\text{SO}_3^{2-}$ , e.t.c) but also the organics (phenols, amines, humic acids, bacteria). In the oxidation processes of pollutants are used as oxidizing agents a series of gaseous and liquid reagents such as: chorine, chlorine dioxide, sodium hypochlorite, fluorine, oxygen (from the air or pure), ozone, hydrogen peroxide, potassium permanganate.

##### ***3.1.1. Types of oxidative methods for waters treatment used in industry***

There are three types of treatments methods: chemical oxidation (which was noted above), photocatalytic and electrochemical.

*Photocatalytic oxidation* is an efficient process that is applied for effluent with low flow. Involves improving reactors and use of semiconductors activated by solar light.



*Electrochemicals oxidation* apply processing wastewater from electroplating and paint shops. This method is done by cathodic or anodic of organic pollutants [11]. Very important is choosing of electrode material.

### **3.2. Advanced oxidation processes (AOP)**

Advanced oxidation processes were defined by Glaze [12] and his collaborators (1987) as treatment processes that occur in temperature and pressure conditions close to those of the environment and involving the generation of radicals with high reactivity (especially hydroxyl radicals) in sufficient quantities to produce clean water [12].

These treatment processes are considered as very promising methods for cleaning groundwaters, surface waters and wastewaters containing non-biodegradable organic pollutants. Hydroxyl radicals are also characterized by a low selectivity of attack on the organic molecule, selectivity is necessary for an oxidant to be used in waste waters treatment.

Simple organic compounds such as: acetic, maleic and oxalic acid, acetone or chlorinated derivatives such as: chloroform, tetrachlorethane can not be attacked by hydroxyl radicals [13]. Application of advanced oxidation processes (AOP) in waste waters treatment involves the use of expensive reagents (ozone and hydrogen peroxide). In these conditions it is prefer to use cheaper methods such as biological degradation. Hydroxyl radicals are very reactive species continuously generated by chemical and photochemical reactions. For this reason advanced oxidation processes are efficient but very expensive.

Are used systems with UV radiation: UV/O<sub>3</sub>, UV/O<sub>3</sub> /H<sub>2</sub>O<sub>2</sub>, Fe<sup>3+</sup>/UV, UV/TiO<sub>2</sub> and peroxide hydrogen: H<sub>2</sub>O<sub>2</sub>/UV, H<sub>2</sub>O<sub>2</sub>/O<sub>3</sub> [14]. These systems are used to treat waste waters containing: aromatic compounds (phenolic), nitroaromatic, organic, pesticides that containing chlorine and phosphorus and polycyclic aromatics hydrocarbons.

## **4. EXPERIMENTALS ASPECTS REGARDING WASTE WATERS TREATMENTS**

As we know industrial and domestic waste water, and natural waters, often contain refractory organic compounds that can persist even after these have been applied purification process, namely treatment. In the category of organic pollutants are a series of aliphatic acids such as: acetic acid, oxalic acid, propionic acid, malonic acid, succinic acid. These acids are produced by partial oxidation of organic matter present in water which were subjected to oxidative treatment processes.

To do as advanced oxidation of organic pollutants in water, preferably until their total mineralization, so to frame in treated water quality parameters imposed by the applicable regulations, develop new methods of treatment more effective. In this way it is necessary to use methods of oxidation using strong oxidizing agents such as: ozone.



Ozone is an oxidizing agent with selective character and attack compounds with high electron density. Efficiency of oxidation can be improved by using catalytic systems that favor the generation of hydroxyl radicals. They have the ability to stabilize the molecules of pollutants by active complex formation on the surface. As shown in the abstract (summary) the scope to the experiment was the testing activity of  $\text{CuO-Al}_2\text{O}_3$  mixed catalyst in the process of oxidation of oxalic, succinic and acetic acid from water.

#### 4.1. Pilot plant and engineering work

Experiments were conducted in a glass reactor (volume = 300 mL, diameter = 30 mm, height = 250 mm) equipped with stirrers and air dispersion of ozone in the catalyst in suspension (Figure 1). The process takes place in the semi-system, aqueous solution is the stationary phase and mobile phase ozonized air.

Ozone generation was achieved using a laboratory technique ozonize lightning in the air.

During these experiments, as target pollutants were used: oxalic acid ( $\text{C}_2\text{H}_2\text{O}_4$ )  $M = 90.4 \text{ g/mol}$ , acetic acid ( $\text{C}_2\text{H}_4\text{O}_2$ )  $M = 60.5 \text{ g/mol}$  and succinic acid ( $\text{C}_4\text{H}_6\text{O}_4$ ),  $M = 60,5 \text{ g/mol}$ . Synthetic solutions of aliphatic acids (the origin Merck) were prepared in demineralized water ( $0.1 \mu\text{S}$ ). The process takes place in the following condition of reaction: volume of solution required process is 200 ml; solutions of oxalic, acetic and succinic acid with concentrations  $10^{-2}\text{M}$ ; catalyst concentration  $0,5- 2 \text{ g}\cdot\text{L}^{-1}$ ; ozone air flow  $20 \text{ L h}^{-1}$ ; ozone dose  $0,7 - 3,5 \text{ mg}\cdot\text{min}^{-1}$ ;  $\text{pH} = 2 -9$ ; atmospheric pressure; temperature  $23 \pm 1^\circ\text{C}$ ; reaction time 15 - 240 min.

#### 4.2. Used Catalyst

The catalyst used during the process is a catalyst type mixed oxide  $\text{CuO-Al}_2\text{O}_3$  impregnated on alumina. It was prepared by precipitation of copper nitrate and sodium bicarbonate and mixing together with alumina powder, followed by filtering, drying and calcination at  $923 \text{ K}$  for 4 hours. Molar ratio  $\text{CuO} : \text{Al}_2\text{O}_3$  is 2:1 and specific surface area (BET) is  $184 \text{ m}^2\text{g}^{-1}$ . Pilot plant used for the process is shown in the picture below.

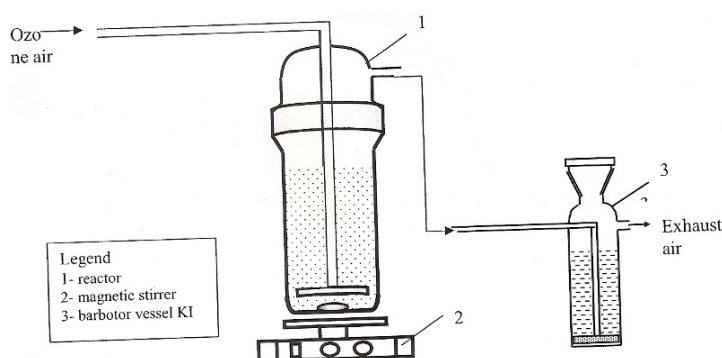

Fig. 1. Ozone oxidation pilot plant in the system semi



### 4.3. Working method

For determination of oxalic, succinic, and acetic acid in aqueous solutions was performed by high performance liquid chromatography (HPLC) with can use a chromatograph Varian Pro Star under the following circumstances: Inertsil column 5 C8 25 cm x 4,6 cm x  $\frac{1}{4}$   $\mu$ m; diode Array UV detector to  $\lambda = 210$  nm; mobile phase: sodium phosphate with concentration 0.1 M and phosphoric acid on pH=2,5; mobile flow rate 1 mL/min; volume of sample injected 10  $\mu$ l. Ph has been measured by a pH/pX meter PHM Radiometer.

### 4.4. Results and discussions

It was found that the succinic, oxalic and acetic acid taken as a reference during experiments are resistant to ozone action. These conversions do not exceed 20% for a reaction time of 240 min, at an ozone dose of 3.5 mg. L<sup>-1</sup>, the lowest responsive presenting an acetic acid conversion with a maximum of 8% (fig. 2-4).

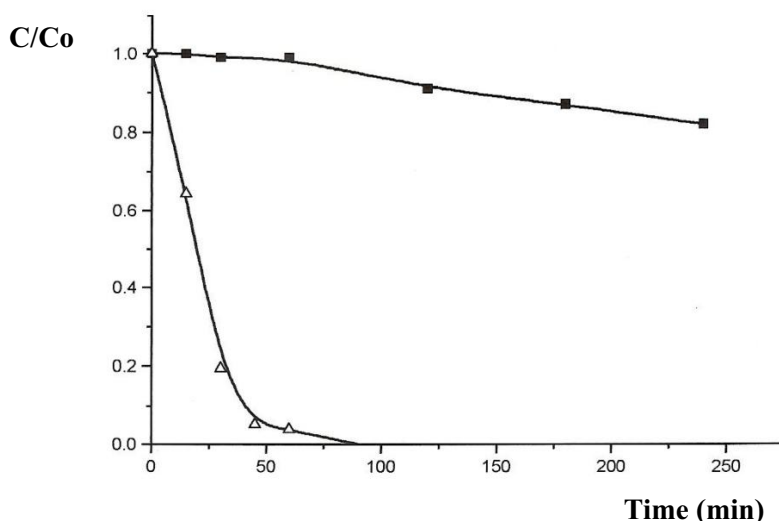

**Fig. 2.** – Shows the degradation of oxalic acid ( $C_0 = 1.10^{-2} \text{ mol.L}^{-1}$ , ozone dose = 3,5 mg. min<sup>-1</sup>; catalyst concentration = 2 g. L<sup>-1</sup>,  $pH_i = 2,0 - 2,1$ );  
■ - uncatalyzed oxidation;  $\Delta$  - catalyzed oxidation

Using the couple  $O_3/CuO-Al_2O_3$  go to a pronounced degradation of acids. As expected, the highest reaction speed is reached for oxalic acid, whose complete degradation is achieved in less than 90 minutes as it is shown in picture number 2. For the rest of acids to a same reaction time the conversions on catalyzed oxidation are 50,1% and 59,3% (fig. 3, 4).

Succinic acid is not totally oxidized. The reaction follows with the formation of oxalic acid as a product of partial oxidation. Maximum concentration of oxalic acid formed is recorded for a reaction time of 90 minutes for a concentration of



$0,52 \times 10^{-2} \text{ mol.L}^{-1}$  and decrease up to concentration of  $0,18 \times 10^{-2} \text{ mol.L}^{-1}$  to a reaction time of 240 minutes according fig. 4.

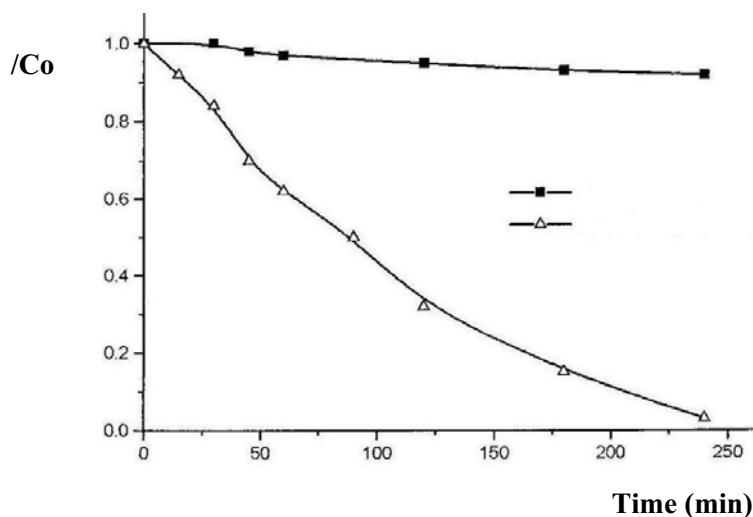

**Fig. 3.** – Shows the degradation of oxalic acid ( $C_0 = 1.10^{-2} \text{ mol.L}^{-1}$ , ozone dose =  $3,5 \text{ mg. min}^{-1}$ ; catalyst concentration =  $2 \text{ g. L}^{-1}$ ,  $pH_i = pH_f = 3,4 - 3,5$ );  
 ■ - uncatalytic oxidation;  $\Delta$  - catalytic oxidation.

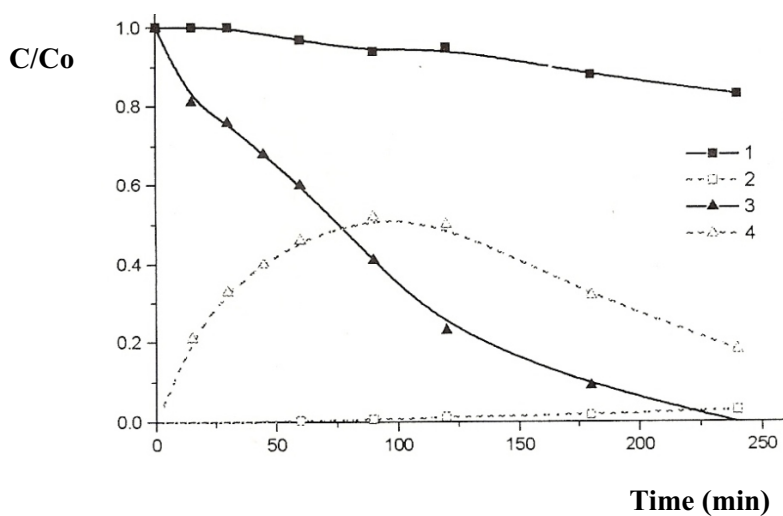

**Fig. 4.** – Presents the degradation of succinic acid as follows: - curve 1- decrease the concentration of succinic acid by uncatalytic oxidation ; curve 2 - oxalic acid formed in uncatalytic oxidation; curve 3- decrease the concentration of succinic acid by catalytic oxidation; curve 4- oxalic acid formed by catalytic oxidation for ( $C_0 = 1.10^{-2} \text{ mol.L}^{-1}$ , ozone dose =  $3,5 \text{ mg. min}^{-1}$ ; catalyst concentration =  $2 \text{ g. L}^{-1}$ ,  $pH_i = 3,2 - 3,4$ ).



#### 4.5. Influence of operational parameters

As is known operational parameters which influence the catalytic oxidation process are: pH, ozone concentration and catalyst concentration. As a target pollutant was used oxalic acid.

##### 4.5.1. Ph influence

Study the influence of pH on oxidation rate of oxalic acid was performed in absence and presence of  $\text{CuO-Al}_2\text{O}_3$  catalyst, for a reaction time of 30 min, the pH values of between 2 and 9. Higher values of pH of reaction medium leads to increase conversion of oxalic acid in the absence and in the presence of catalyst, with up to 16-19%. This evolution on the conversion of oxalic acid can be explained by the fact that the decomposition of ozone by forming highly reactive radicals  $\text{HO}\cdot$  is favored in alkaline medium (Langlais 1991) in according to fig. 5.

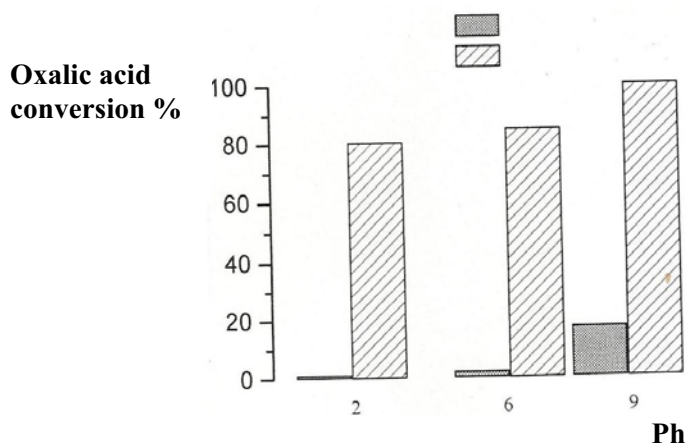

**Fig. 5. The influence of pH on oxalic acid degradation** (reaction time = 30 min,  $C_0 = 1.10^{-2} \text{ mol.L}^{-1}$ , ozone dose  $3,5 \text{ mg. min}^{-1}$  and catalyst concentration =  $2 \text{ g. L}^{-1}$ ) for uncatalytic oxidation and catalytic oxidation.

##### 4.5.2. Influence of ozone dose

The Influence of ozone dose applied in the field of concentration from 0.7 to  $3.5 \text{ mg.min}^{-1}$ , was studied in the presence and the absence of catalyst. According to Fig. 6, removal of oxalic acid is more advanced with the increasing dosage of ozone.

##### 4.5.3. Influence of catalyst concentration

Influence of catalyst concentration on oxidation process of oxalic acid is notable in the field of concentration  $0,5 - 1,5 \text{ g.L}^{-1}$ .  $\text{CuO-Al}_2\text{O}_3$  catalyst used in the ozone oxidation process of oxalic acid, succinic acid presents important activity





allowing to achieve a more advanced degree of removal of these contaminated (pollutants) from waters.

The increase of catalyst concentration over the range of values doesn't lead to a significant increase of conversion for oxalic acid (fig. nr.7).

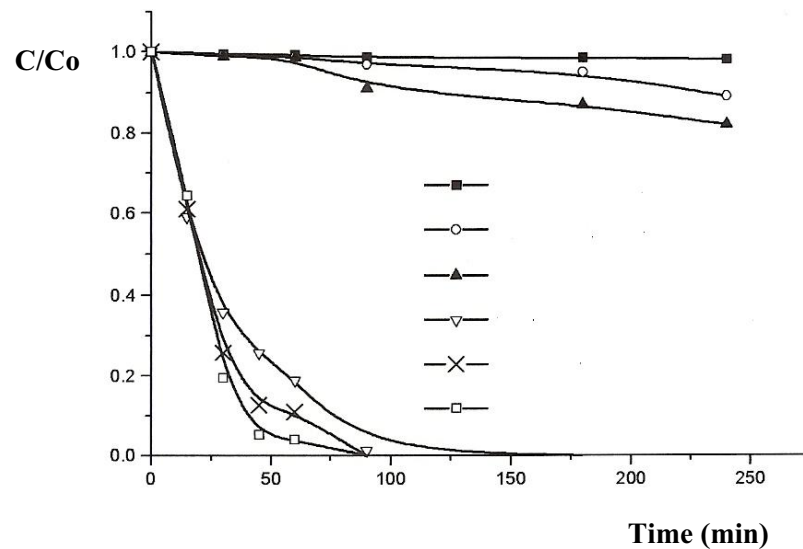

**Fig. 6. Influence of ozone dose on the degradation of oxalic acid**  
 ( $C_0 = 1.10^{-2} \text{ mol.L}^{-1}$ ; catalyst concentration =  $2 \text{ g. L}^{-1}$ ;  $pH_i = 2,0 - 2,1$ );

- - oxidation with ozone  $CO_3 = 0.7 \text{ mg.m}^{-1}$ ; ○ - oxidation with ozone  $CO_3 = 2.1 \text{ mg.m}^{-1}$ ;
- ▲ - oxidation with ozone  $CO_3 = 3.5 \text{ mg.m}^{-1}$ ; x - catalytic oxidation.  $CO_3 = 2.1 \text{ mg.m}^{-1}$ ;
- - catalytic oxidation  $CO_3 = 3.5 \text{ mg. mg.m}^{-1}$ ; ▽ - oxidation with ozone  $CO_3 = 3.5 \text{ mg.m}^{-1}$

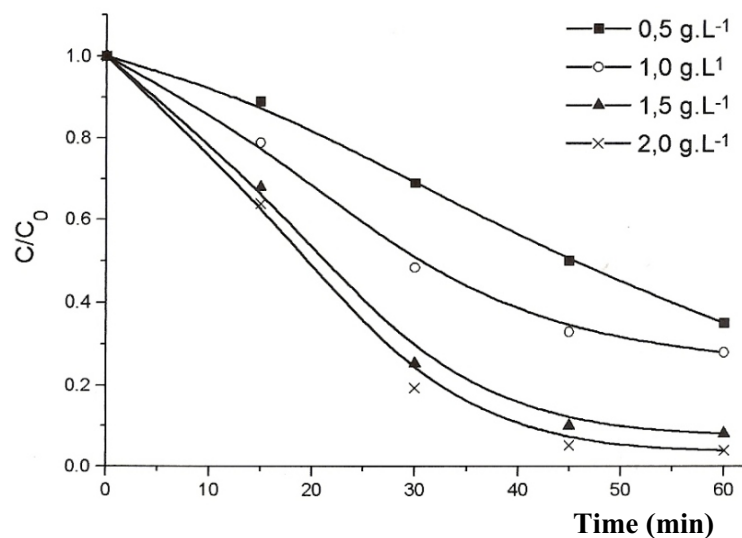

**Fig. 7. Influence of catalyst concentration on the degradation of oxalic acid**  
 ( $C_0 = 1.10^{-2} \text{ mol.L}^{-1}$ , ozone dose =  $3,5 \text{ mg. min}^{-1}$ ,  $pH_i = 2,0 - 2,1$ ).



## 5. CONCLUSION

Studying the influence of operational parameters on oxidation process of oxalic acid shows the following aspects:

- The oxidation of oxalic acid in alkaline medium is favored, probably due to the formation in these conditions of hydroxyl radicals;
- Increasing the ozone dose leads to a moderate increase of oxalic acid conversion, keeping the differences between the catalytic and uncatalytic process;
- Changing the catalyst concentration in the field of concentration 0,5 –1,5 g.L<sup>-1</sup> leads to noticeable increase of reaction speed for oxalic acid oxidation;
- In these reaction conditions oxalic acid is degraded more quickly.

## REFERENCES

1. Duinker, Nolting, 1977, *Marine Pollution Bulletin* 8 (3) p.70
2. Refs. Schwertmann, U., *Z. Pflanzenernährung, Düngemittel, Bodenkunde* 105, 4-202, 1964; Tessier, A., Campbell, P.G.C., Bisson, M., *Anal. Chem.* 51, 844-851, 1979.
3. Nolting, R.F., De Baar, H.J.W., *Netherlands Institute for Sea Research (NIOZ)*, Annual Report, 1, 23-24, 1990.
4. Toader, C., Chițimiea, C.S., Pătroescu C. – *Dispariția unor pesticide cu toxicitate medie din biotopul unui ecosistem acvatic*, *Rev. de Chimie*, 3, 233-238, 2000.
5. Ministerul Mediului și Gospodării Apelor, *Codul Bunelor Practici Agricole*, vol. I - *Protecția apelor împotriva poluării cu fertilizanți proveniți din agricultură și prevenirea fenomenelor de degradare a solului provocate de practicile agricole*.
6. Banerjee, S.; Sugatt, R.H. s.a. – *Environmental Hazard Assessment of Effluents*, Pergamon Press, New York, 1982.
7. U.S. DEPARTMENT OF HEALTH AND HUMAN SERVICES, Public Health Service, Agency for Toxic Substances and Disease Registry, *Toxicological Profile Information Sheet*.
8. MSC-E Technical Report 4/2003 *"Persistent Organic Pollutants in the Environment"* V.Shatalov, M.Fedyunin, E.Mantseva, B.Strukov, N.Vulykh.
9. Ion Udrea, Sorin Avramescu, *Tehnologie Chimică Generală*, Editura Ars Docendi, 2003, p. 162-165.
10. Chamarro, E., Marco, A., Prado, J. and Esplugas, S. (1996) *„Tratamiento de aguas y aguas residuales mediante utilización de procesos de oxidación avanzada”*, *Química & Industria*, 1, 28-32.
11. Gh. Duca, M. Macoveanu, M. Surpateanu, A. Misiti, *Chimie Ecologică*, Editura Matrix Rom, 1999, p. 281.
12. Glaze, W. and Chapin, D. (1987) *„The chemistry of water treatment processes involving ozone, hydrogen peroxide and ultraviolet radiation”*, *Ozone Sci. & Eng.*, 9: 335-342.
13. Bigda, R. (1995) *„Consider Fenton's chemistry for wastewater treatment”*, *Chem. Eng. Progr.*, 91: 62-66.
14. Coșeci, V. - *„Tehnologie chimică generală”*, Centrul de multiplicare IPT, Timișoara, 1993.